



SISTEMA DE ENGANCHE REFORZADO ST5
TOYOTA HILUX
 PARAGOLPES CROMADO 2005-2015



SE040

Las marcas y modelos utilizadas sólo a modo ilustrativo en este documento son propiedad de sus respectivos titulares legítimos

BSE001
 M12P1.75
 x35mm

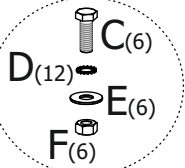

BSE025
 M12P1.75
 x35mm

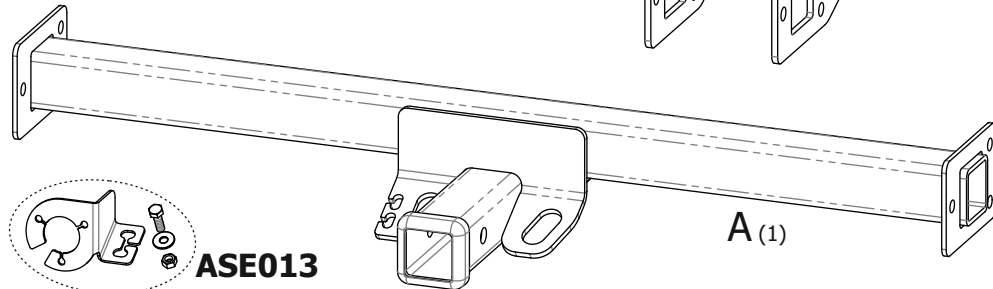
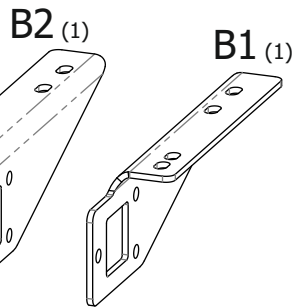
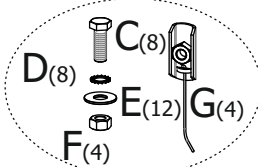

1. CONTENIDO

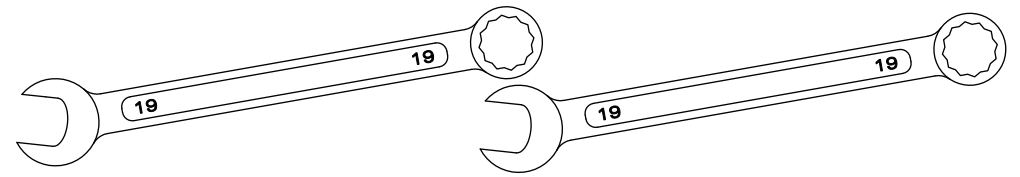

2. HERRAMIENTAS NECESARIAS

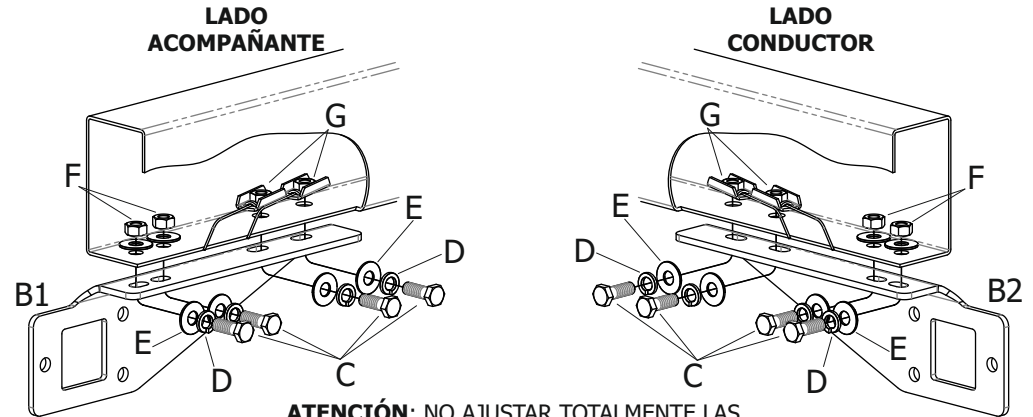

ATENCIÓN: NO AJUSTAR TOTALMENTE LAS PLACAS HASTA COLOCAR EL TRAVESAÑO (A)

3. COLOCACIÓN DE PIEZAS "B1" Y "B2"



M12 Gr 8.8: 85 Nm
M8 Gr 8.8: 22 Nm

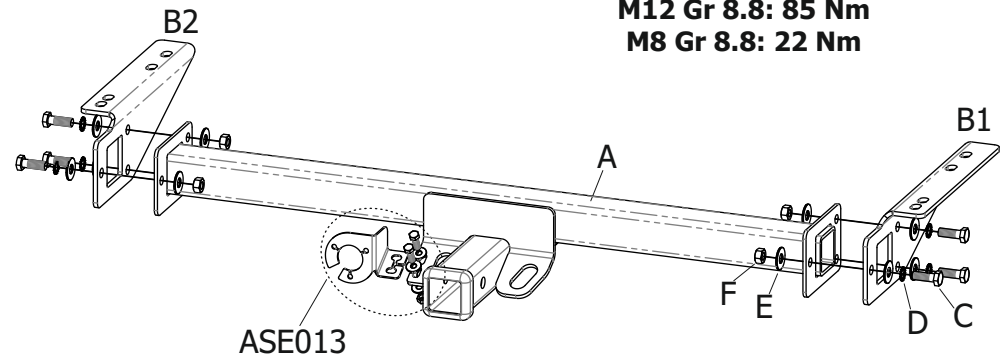

4. COLOCACIÓN DE PIEZAS "A" Y "K"