

SISTEMA DE ENGANCHE LIVIANO ST1 EVW7498 VOLKSWAGEN SURAN 2010-> INSTALACIÓN - EMBALADO

ACCESORIOS SUGERIDOS

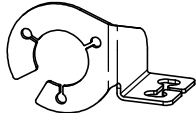

ASE012

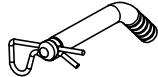

EAC0607

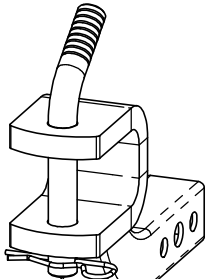

EAC0615

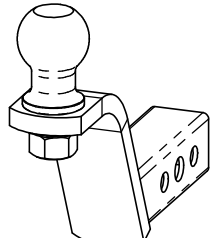

EAC0612

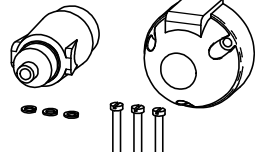

ASE011

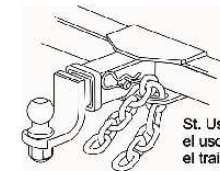
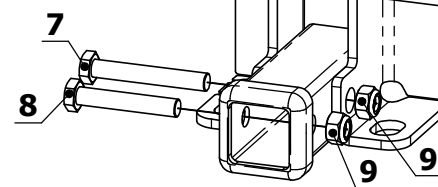
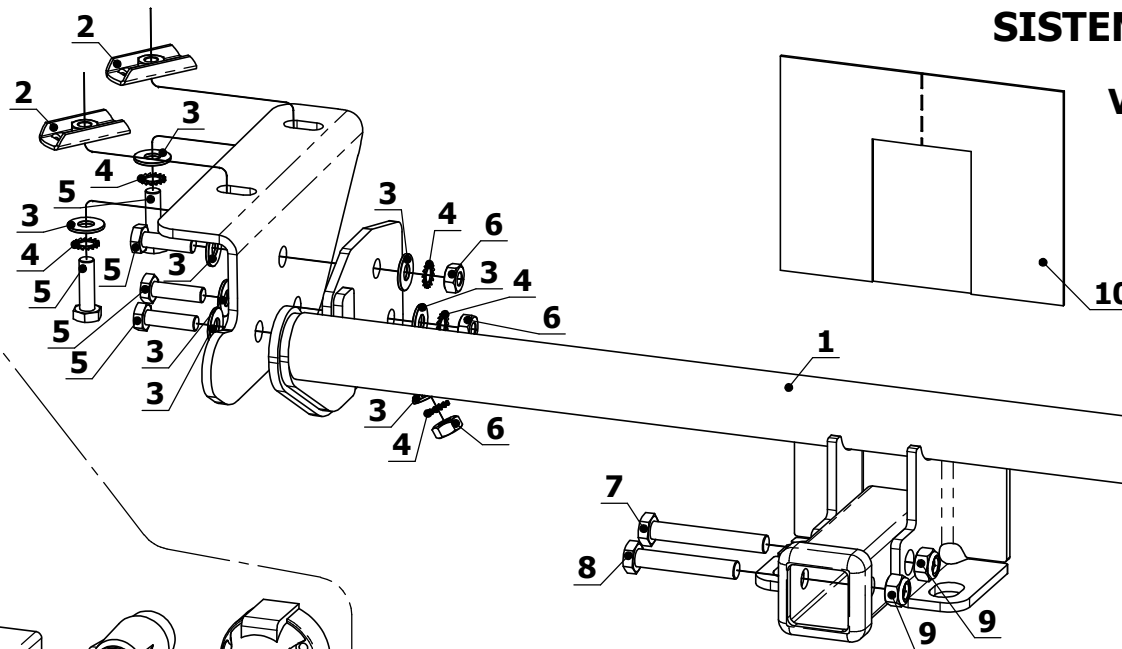

St. Usuario: es obligatorio el uso de cadenas, uniendo el trailer al enganche.



ID	PIEZA	CANT.
1	EVW7498	1
2	PLACA ANCLAJE M10 ZINC.DOR.	4
3	ARANDELA PLANA Ø10 ZINC.DOR.	10
4	ARANDELA DENTADA Ø10	7
5	TORNILLO HEX. ZINC.DOR.GR.8.8 M10 P1.5 X 35mm	7
6	TUERCA C/FRENO HEX. ZINC.DOR.GR.8.8 M10 P1.5	3
7	TORNILLO HEX. ZINC.DOR.GR.8.8 M12 P1.75 X 80mm	1
8	TORNILLO HEX. ZINC.DOR.GR.8.8 M12 P1.75 X 70mm	1
9	TUERCA C/FRENO HEX. ZINC.DOR.GR.8.8 M12 P1.75	2
10	PLANTILLA DE RECORTE DE PARAGOLPES	1
11	CALCO ST1 VERDE	1
12	CALCO ATENCIÓN	1

Instalación:

- 1). Realizar un agujero con una mecha tipo copa Ø 27mm o agrandar uno de los agujeros de anclaje del chasis para, luego, introducir las placas de anclaje M12 (en ambos lados).
- 2). Colocar la placa suelta del lado conductor y luego montar el resto del enganche.
- 3). Sujetar el enganche firmemente al vehículo mediante los tornillos, arandelas grove y planas suministradas.

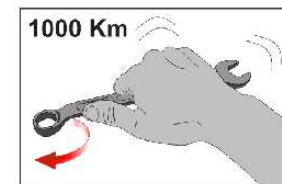
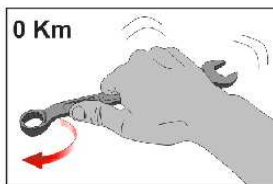
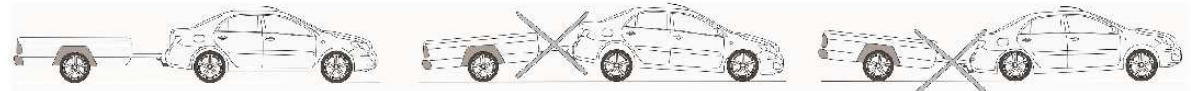

VALORES DE APRIETE DE TORNILLOS GRADO 8.8				
	M8	M10	M12	M14
Kg. m	2.5	5.1	8.7	14

Coefficiente de fricción μ_k : 0,14